



NATIONAL INSTITUTE FOR RESEARCH, DEVELOPMENT
AND TESTING IN ELECTRICAL ENGINEERING

ICMET CRAIOVA
HIGH VOLTAGE DIVISION

Low and High Voltage Testing Laboratory
for Electrical Equipment (LHVL)

200746 CRAIOVA, Blvd. DECEBAL, No.118A, ROMANIA
Matriculation certificate: J16/312/1999, VAT number: RO3871599
Phone: + 40 0351 402425, 404888; Fax: + 40 0351 404890
www.icmet.ro ; E-mail: market@icmet.ro



Copy 1/4
accredited for
TESTING

SR EN ISO/CEI 17025:2005
ACCREDITATION CERTIFICATE
LI 1036

TEST REPORT
No. 46806 / 30.07.2019

CUSTOMER: SCHIRTEC AG
Address: Ignaz-Köck Strasse 10 / A-1210 Wien / AUSTRIA

MANUFACTURER: SCHIRTEC AG
Address: Ignaz-Köck Strasse 10 / A-1210 Wien / AUSTRIA

TESTED PRODUCT: Early Streamer Emission (ESE) Lightning Conductor
type SCHIRTEC- A (S-A)

REFERENCE STANDARD: NFC 17-102:2011, Annex C
UNE 21186: 2011, Annex C

PERFORMED TESTS: I. General tests
I.1 Documentary information and identification
I.2 Marking tests
II. Mechanical tests - Inspection of dimensional characteristics
III. Environmental tests
III.1 Salt mist treatment
III.2 Humid sulphurous atmosphere treatment
IV. Early streamer emission tests

TEST PERIOD: 09.07.2019 ÷ 29.07.2019

TEST RESULTS: For test I.1 see page 4, for test I.2 see page 5, for test II see page 5, for test III.1 see page 6, for test III.2 see page 8, for test IV see pages 12, 13 and 15.

The test report contains 20 pages and is edited in 4 copies, copy no.1 remains in laboratory and copies 2, 3, 4 are sent to the customer.

HEAD OF HVD – TECHNICAL MANAGER,

Eng. Ion BURCIU



**HEAD OF MECHANIC and
ENVIRONMENT TEST TEAM,
Eng. Alin NEAGOE**

**HEAD OF ELECTRIC TESTS TEAM
Eng. Laurentiu VLĂDOI**

Warnings:

- The results refer only to the tested product.
- Publication and reproduction of the contents of this report in any other form unless its complete photocopying is not allowed without writing approval of Division to which laboratory belongs.
- All signatures of the present report are original ones.



CONTENTS:

Identification of the test product Page 3

Technical characteristics declared by the manufacturer Page 3

Tests program Page 3

Responsible for tests Page 3

Present at the tests Page 3

I. General tests

 I.1 Documentary information and identification Page 4

 I.2 Marking tests Page 5

II. Mechanical tests - Inspection of dimensional characteristics Page 5

III. Environmental tests

 III.1 Salt mist treatment Pages 6, 7

 III.2 Humid sulphurous atmosphere treatment Pages 8, 9

IV. Early streamer emission tests..... Pages 10 ÷18

Annexes..... Pages 19, 20



1. IDENTIFICATION OF THE TEST PRODUCT

Type: SCHIRTEC- A (S-A)
Serial / year: Serial number 082921
Technical Specification / Drawing: Drawing no. SCH.101 (Annex 2)
Contract / Test order: No. 705.2 / 1121 / 05.06.2019
Internal test order: 23817 / 18.06.2019
Product receiving date: 01.07.2019
Product condition at receiving: New

2. TECHNICAL CHARACTERISTICS ESTABLISHED BY MANUFACTURER

See Annex 1 page 19

Early streamer emission efficiency $\Delta T = 60 \mu s$

3. TESTS PROGRAM

I. General tests	C.3.1
I.1 Documentary information and identification	C.3.1.1
I.2 Marking tests	C.3.1.2
II. Mechanical tests - Inspection of dimensional characteristics	C.3.2
III. Environmental tests	
III.1 Salt mist treatment	C.3.3.1
III.2 Humid sulphurous atmosphere treatment	C.3.3.2
IV. Early streamer emission tests	C.3.5

4. RESPONSIBLE FOR TEST

Eng. Luminița TAȘCĂU	(I, II)	
Tech. Ioana PĂTRU	(III)	
Eng. Laurențiu VLĂDOI	(IV)	

5. PRESENT AT THE TEST

I. GENERAL TESTS

I.1 DOCUMENTARY INFORMATION AND IDENTIFICATION

1. Test date: 09.07.2019
2. Test standard: NFC 17-102:2011, Annex C, clause C.3.1.1
3. Atmospheric conditions: temperature 20,9°C; relative humidity 53,1%
4. Equipment used: –
5. Test procedure: The ESE Lightning Conductor was identified by the following information indicated on the product (marking), Photo 1 and 2:
 - Trade mark (and logo) of the manufacturer: SCHIRTEC®
 - Early streamer emission efficiency: $\Delta T = 60 \mu s$
 - Serial number: 082921The checking of the identification of marking was carried out by visual inspection.
6. Test results: Identification of marking was according to the requirements of C.2.1.1 of the NFC 17-102.

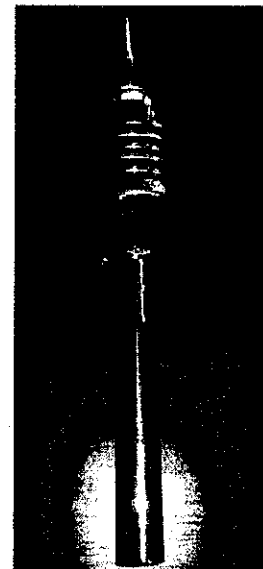
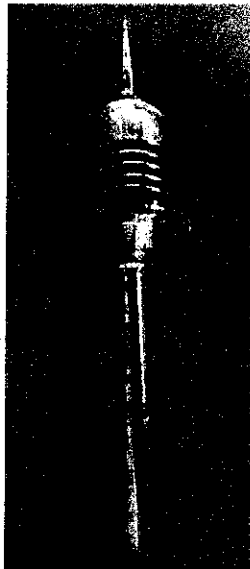

Photo 1 Tested product

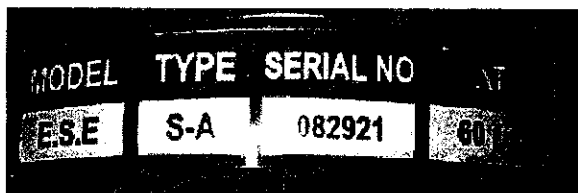

Photo 2 Product labels

I.2 MARKING TESTS

1. **Test date:** 09.07.2019
2. **Test standard:** NFC 17-102:2011, Annex C, clause C.3.1.2
3. **Atmospheric conditions:** temperature 20,9°C; relative humidity 53,1%
4. **Equipment used:** **Material:** hexane aliphatic defined by a 0.1% maximum content of aromatic carbide in volume (Note 1, clause C.3.1.2)
5. **Test procedure:** The test was carried out by rubbing the marking by hand for 15 s with a cotton rag dipped in water and for 15 s more with a cotton rag dipped in hexane aliphatic.
6. **Test results:** After the test the marking was legible (Photo 3).

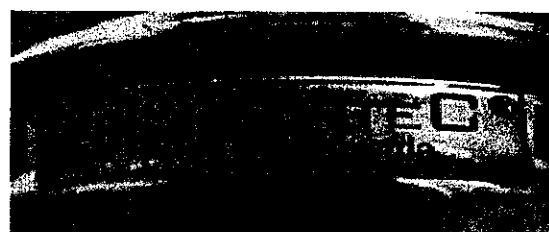
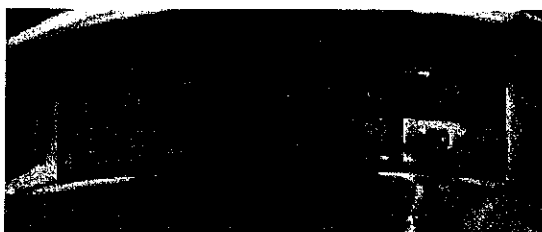

Photo 3 Product labels after the test

II. MECHANICAL TESTS - INSPECTION OF DIMENSIONAL CHARACTERISTICS

1. **Test date:** 09.07.2019
2. **Test standard:** NFC 17-102:2011, Annex C, clause C.3.2
3. **Atmospheric conditions:** temperature 20,9°C; relative humidity 53,1%
4. **Equipment used:**
 - Digital calliper, serial no. 5V0064501, manufacturer TESA Switzerland, CC no. 0906DJ16/01.02.2017, DRML Craiova
 - Digital calliper with vernier 1000 mm, type D 10233, serial no. D 18051 manufacturer China, CC no. 01.01-128/2017, INM Bucuresti
5. **Test procedure:** The checking of the dimensional characteristics with their tolerances was carried out according to manufacturer drawing no. SCH.101 (Annex 2). The tolerance is $\pm 3\%$ for all dimensions.

Dimension (mm)	Ø24	20	Ø116	Ø30	230	8	44
Measured value (mm)	Ø24	20	Ø115.5	Ø30	231	8.1	45

Dimension (mm)	97	6	4	140	583
Measured value (mm)	96	6	4	139.9	584

6. **Test results:** The difference between the measured values and the rated dimensions has complied with the specified tolerance.

III. ENVIRONMENTAL TESTS

III.1 SALT MIST TREATMENT

1. Test period: 09.07.2019 – 12.07.2019
2. Test standard: NF C 17-102:2011, Annex C, clause C.3.3.1,
UNE 21186: 2011, Annex C, clause C.3.3.1
SR EN 60068-2-52:2002
3. Atmospheric conditions: temperature 25,5°C-27,3°C, relative humidity 63-65%
4. Equipment used:
 - Salt mist chamber, tip SC/KWT 1000, manufactured by Weiss Umwelttechnik Germany, serial no 59226175160010, calibration certificate no.07837-06.19
 - Climatic chamber, climatic room Votsch Germany ,type VC 40 60 ,series 59566092700010 calibration certificate no. 07836-06.19
 - Portable conductivity meter, type 3210, manufactured by WTW Germany, serial no. 15440615 /2015, calibration certificate no. 132.05/03.03.2016
 - pH meter, type SD50, serial no. 0815/49481, calibration certificate Nr. 6134DJ18/18.02.2019
 - Thermohygrometer type HD 100, serial 06102402, manufactured by KIMO France, calibration certificates no. 4174Dj17/03.2018 (for thermometer function) and no. 4175Dj17/03.2018 (for hygrometer function)

5. Test procedure:

The test was carried out with level 2 severity.

The product was placed in the salt mist chamber (Photo 4) and it was sprayed for 2 h with a 5% sodium chloride solution at ambient temperature. At the end of the spray period, the product was transferred to the climatic chamber (Photo 5) and stored for 22 h at a temperature of 40°C and a relative humidity of 93%.

A cycle consists in a period of exposure to salt mist and a period of storage to moisture. The product was subjected to 3 (three) such conditioning cycles.

The salt mist treatment diagram is presented in Photo 6.

6. Test result:

The product was conditioned for the humid sulphurous atmosphere test.

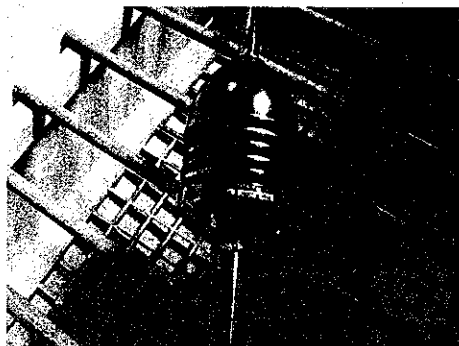

Photo 4

Product inside the salt mist chamber

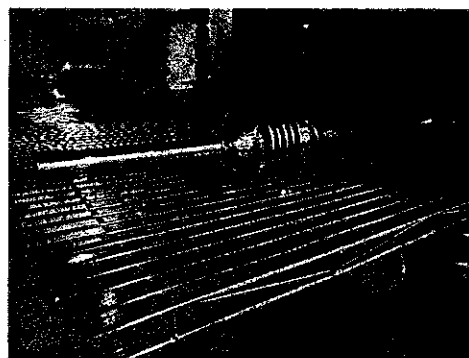

Photo 5

Product inside the climatic chamber



VC4060 [no1] prog.:Paratrasnet1 SCHIRTEC arch.Paratrasnet1 SCHIRTEC start:Chamber 09.7.2019 Paratrasnet1 SCHIRTEC

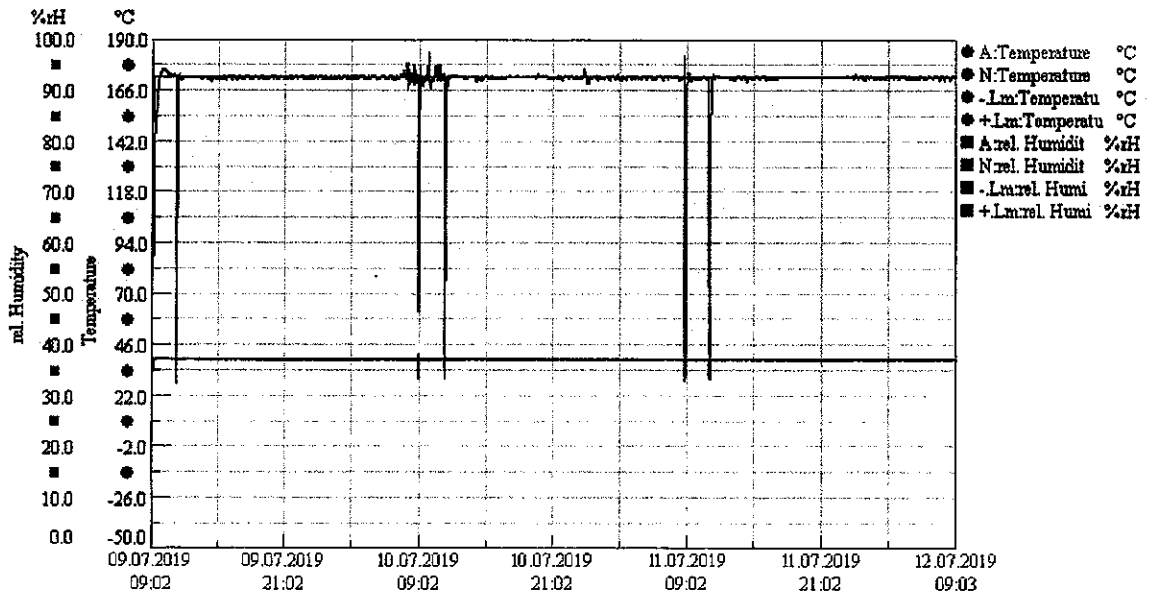

Photo 6
Salt mist treatment diagram

III.2 HUMID SULPHUROUS ATMOSPHERE TREATMENT

1. **Test period:** 12.07.2019 – 19.07.2018
2. **Test standard:** NF C 17-102:2011, Annex C, clause C.3.3.2
UNE 21186: 2011, Annex C, clause C.3.3.2
SR EN ISO 6988:1997
3. **Atmospheric conditions:** temperature 25,2°C-26°C, relative humidity 63-64%
4. **Equipment used:**
 - Humid sulphurous atmosphere chamber, type V.702.861.101, manufactured by VLM Germany, serial no.1701901, calibration certificates BURKERT Nr.72010935/24.11.2016 and VLM nr. 14609/03.02.2017
 - Thermohygrometer type HD 100, serial 06102402, manufactured by KIMO France, calibration certificates no. 4174Dj17/03.2018 (for thermometer function) and no. 4175Dj17/03.2018 (for hygrometer function)
5. **Test procedure:**

The product was subjected to 7 (seven) conditioning cycles in humid sulphurous atmosphere chamber (Photo 7). Each cycle lasted 24 hours and included an 8-hour heating period at a temperature of 40 °C in a saturated humid environment, followed by a 16-hour standing period. After this standing period, the humid sulphurous atmosphere was restored.

At the beginning of each cycle, 2 dm³ of distilled water were introduced into the test chamber and 0.2 dm³ of sulphur dioxide were dosed inside using an electronic mass flow meter. Simultaneously, the heating was started and it was created a humid sulphurous atmosphere at 40 °C. The product was kept in the above conditions for 8 hours, followed by 16 hours aeration inside the test chamber at 23 °C.

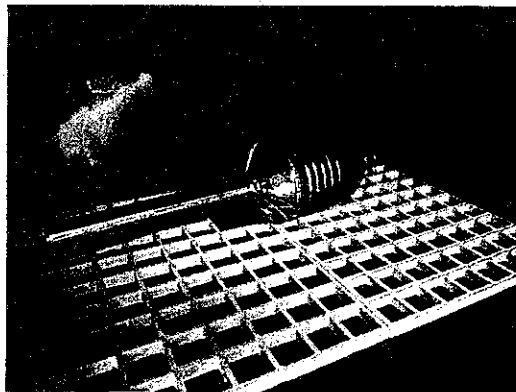

Photo 7

Product inside the humid sulphurous atmosphere chamber

6. Test result:

The product was conditioned for the electrical tests. The product at the end of the test is shown in photo 8, photo 9 and photo 10



Photo 8



Photo 9

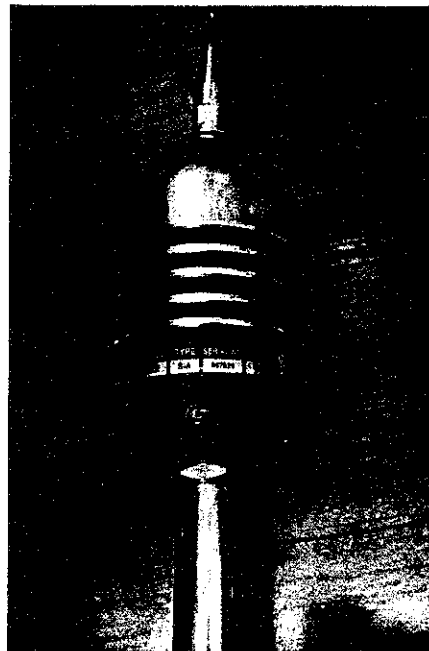

Photo 10



IV. EARLY STREAMER EMISSION TESTS

1. Test date: 29.07.2019
2. Test standard: NFC 17-102:2011, Annex C
UNE 21186: 2011, Annex C
3. Atmospheric conditions:

While testing the S.R.A.T

BEFORE TEST:	p = 1006 mbar t = 25.3 °C h _r = 60.8 %
MIDDLE OF THE TEST:	p = 1006 mbar t = 25.4 °C h _r = 60.9 %
END OF THE TEST:	p = 1006 mbar t = 25.7 °C h _r = 61 %

While testing the E.S.E.A.T

BEFORE TEST:	p = 1006 mbar t = 25.7 °C h _r = 61 %
MIDDLE OF THE TEST:	p = 1005 mbar t = 23.7 °C h _r = 60.7 %
END OF THE TEST:	p = 1005 mbar t = 23.7 °C h _r = 60.6 %

4. Equipments and apparatus used:

Laboratory inner dimensions: 48 m x 32 m x 27 m (height); Altitude: 100 m above sea level;

4200 kV High Voltage Impulse Generator type SPF 336; 336 kW,
TUR Dresden – Germany;

1000 kV Rectifier cascade type GS 1000 / 30; 30 mA; TUR Dresden – Germany;

1400 kV Damped divider type RC 1400, serial no. 03/1996, ICMET Craiova,
Romania; TR – AS Transient – Recorder, Dr. Strauss System Elektronik,
serial no.228 GmbH – Germany; Digital multimeter Keithley, serial no.
1070037 – USA.

See the test circuit diagram on page 17.

**The measuring systems consist of:****- For SI:**

- High Voltage Measuring system for switching impulse, 1400 kV that consist of:
 - Divider type RC 1400, serial no.03 / 1996 – manufacturer by ICMET Craiova.
 - Transient Recorder type TR-AS 100-10 / 4, serial no. 228, manufacturer by Dr. Strauss GmbH;
 - Coaxial measuring cable, 75Ω, 40m.The measuring uncertainty is 1.43% for peak voltage value and 3.86% for peak time parameter according to the Calibration Certificate no.85 / 09.2016.

- For DC:

- 1MV - DC High Voltage Measuring system that consists of:
 - DC resistive divider (serial no.3-35/1),
 - Digital multimeter type Keithley (serial no.1070038)
 - Coaxial measuring cable, 50Ω, 25mThe measuring uncertainty is ±1% according to the Calibration Certificate, no. 44 / 07.2015.

- For climatic parameters:

- Measuring system used for recording the climatic parameters (type ALMEMO 2390-5) consists of:
 - digital thermometer type 2390-5, serial no.H07040351, measuring uncertainty 0.30% according to Calibration Certificate no.04.01-157/2016;
 - digital barometer type 2390-5, serial no.SN 07020126 measuring uncertainty 0.07% according to Calibration Certificate no.02.02-041/2016;
 - digital hygrometer type 2390-5, serial no.H07040351, measuring uncertainty 1.8% according to Calibration Certificate no.05.02-195/2016.

5. Test procedure / test set-up / working mode:

See the test set up on page 18

See photos on the page 16

The tested S.R.A.T. / E.S.E.A.T. were set on a square support with a 0.2m side and connected to ground.

A square metallic plane with dimensions: 4.5 m / 4.5 m / 0.2 m having the edges rounded, was suspended above the lightning conductor.

On the upper metallic plate there were applied at the same time the DC polarization voltage and the switching impulses (250 / 2500 μs), both having negative polarity.

The switching impulse voltage was determined by using a simplified "up and down" procedure in order to obtain the value U100 with a final precision of 1%.

The DC voltage was adjusted in order to create an electric field between the two metallic plates in the range of – 20 to – 25 kV / m (effectively 22.4 kV / m).

Tests were performed in the same conditions and configuration for each lightning conductor: E.S.E.A.T. and S.R.A.T.

The atmospheric conditions were taken at the beginning, at the middle and at the end of each test.

First, there were applied 50 impulses on the S.R.A.T. and after that 50 more impulses were applied on the E.S.E.A.T.

The early streamer emission lightning conductor (E.S.E.A.T.) is compared with a reference single rod lightning conductor (S.R.A.T.).

The peak value (Up) of the impulses and the triggering time (T_B) were recorded for each impulse.

The height of the lightning conductor (h) and the distance between the two metallic plates (H) were measured at the beginning of each test.

Height of lightning conductor (h) adjusted to:	1182 mm
Distance between the upper plate and the ground (H):	2450 mm
h / H:	0.482
Polarization voltage:	54.86 kV
Peak time / Rise time of the full wave:	238 μs / 99.2 μs
Time interval between consecutive impulses:	2 ms



6. Test results:

6.1. test results for S.R.A.T.

The average value of significant break-down times (T_B) calculated from the experimental results (table below) is $T_{SRAT} = 150.6 \mu s$ with a standard deviation $\sigma_{SRAT} = 22.9 \%$.

By transferring T_{SRAT} on the reference waveform it was obtained $T'_{SRAT} = 415.5 \mu s$ (see graphic from page 14).

Impulse no.	T_B [μs]	Impulse no.	T_B [μs]
1	140	41	198
2	176	42	137
3	110	43	156
4	205	44	145
5	143	45	160
6	153	46	123
7	195	47	115
8	141	48	139
9	184	49	221
10	115	50	109
11	180		
12	109		
13	130		
14	154		
15	142		
16	164		
17	247		
18	141		
19	158		
20	115		
21	137		
22	114		
23	174		
24	206		
25	146		
26	136		
27	191		
28	118		
29	168		
30	207		
31	106		
32	127		
33	110		
34	154		
35	175		
36	125		
37	103		
38	115		
39	191		
40	121		

T_B : Break-down time



6.2. Test results for E.S.E.A.T.

The average value of significant break-down times (T_B) calculated from the experimental results (table below) is $T_{E\text{SEAT}} = 126.2 \mu\text{s}$ with a standard deviation $\sigma_{E\text{SEAT}} = 17.3 \%$.

By transferring $T_{E\text{SEAT}}$ on the reference waveform it was obtained $T'_{E\text{SEAT}} = 352.1 \mu\text{s}$ (see graphic from page 14).

Impulse no.	T_B [μs]	Impulse no.	T_B [μs]
1	142	41	104
2	171	42	126
3	107	43	152
4	159	44	126
5	141	45	142
6	147	46	123
7	131	47	111
8	102	48	127
9	101	49	97
10	131	50	172
11	185		
12	115		
13	165		
14	94		
15	104		
16	115		
17	116		
18	116		
19	120		
20	124		
21	117		
22	122		
23	116		
24	119		
25	125		
26	157		
27	92		
28	159		
29	107		
30	124		
31	107		
32	144		
33	111		
34	126		
35	102		
36	117		
37	128		
38	144		
39	120		
40	106		

T_B : Break-down time

Graphic 1 – Determination of the early streamer emission of the E.S.E.A.T

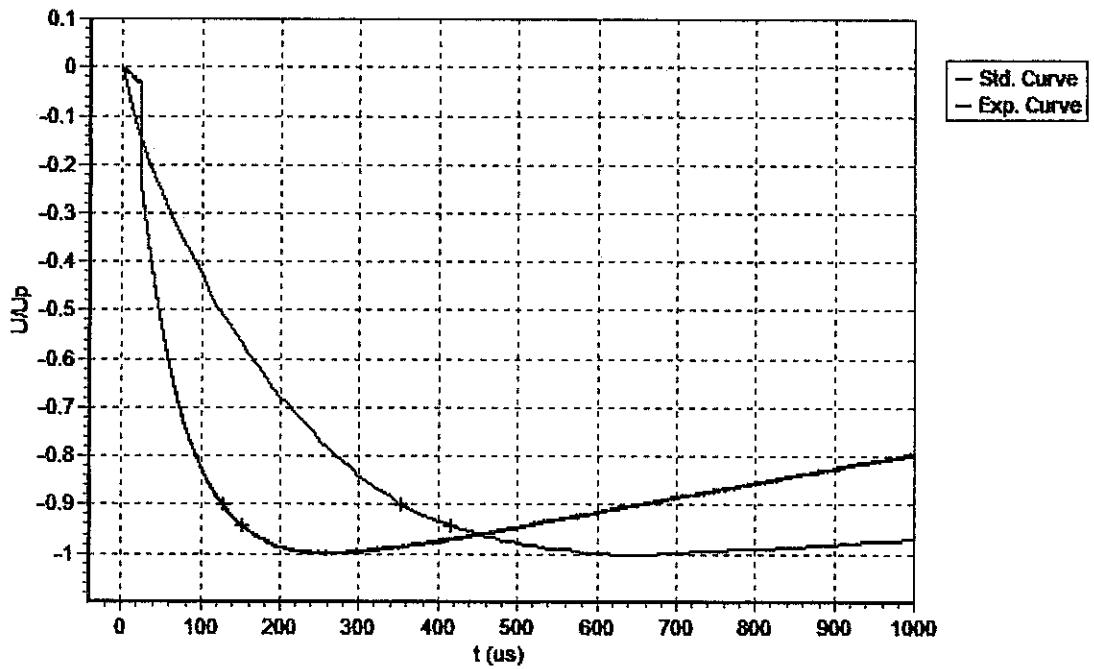

Where:

- On OX axes there is represented time in μs ;
- On OY axes there is represented amplitude U / U_{peak} in relative units;
- Green line is the experimental waveform;
- Red line represents the standard waveform.



6.3. Conclusion:

From all shown so far it can be concluded that the triggering advance is:

$$\Delta T = T'_{SRAT} - T'_{ESEAT} = 415.5 - 352.1 = 63.4 \mu\text{s} \pm 2 \mu\text{s}$$

Measuring uncertainty for ΔT is 3.2 %.

The uncertainty stated is expanded uncertainty obtained by multiplying the standard uncertainty by the coverage factor $k = 2$. The value of measurand lies within the assigned range of values with probability of 95 %.

The tested lightning conductor is an E.S.E.A.T. (early streamer emission air terminal) because it fulfils all the conditions stipulated by standard (according to NFC 17-102 :2011, Annex C, clause C.3.5.2.5):

- $T_{ESEAT} < T_{SRAT}$ (126.2 < 150.6)
- $\sigma_{ESEAT} < 0.8 \sigma_{SRAT}$ (17.3 % < 0.8 · 22.9 % = 18.3 %)
- $T'_{SRAT} - T'_{ESEAT} > 10 \mu\text{s}$

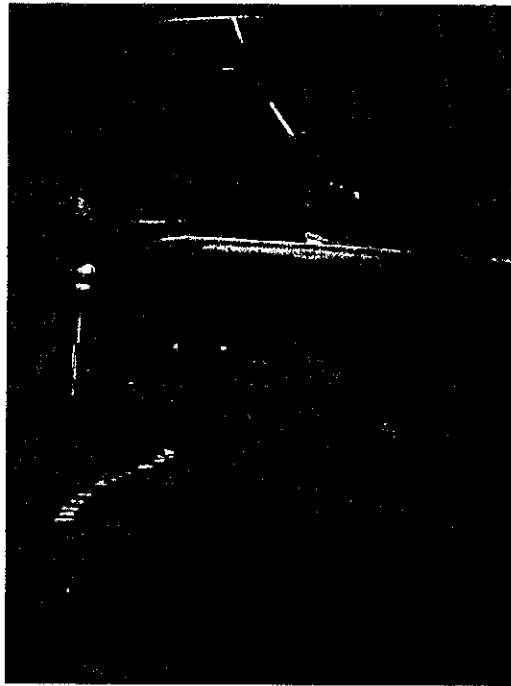

Photo 11

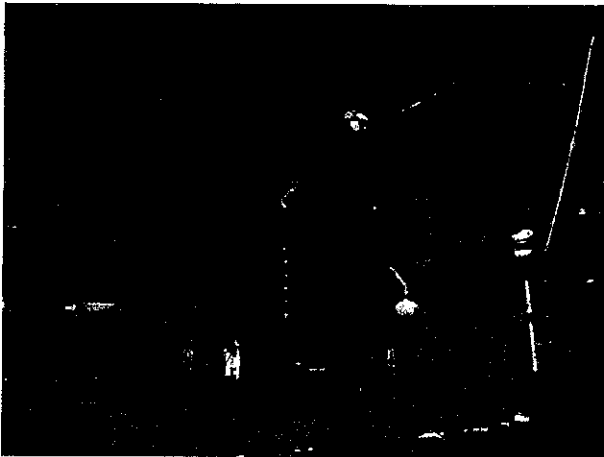

Photo 12

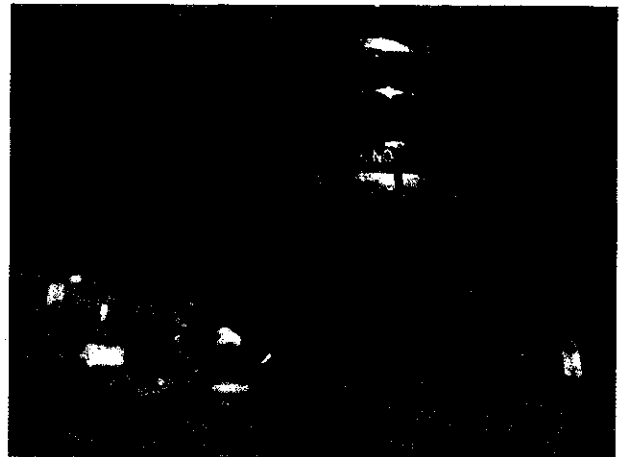
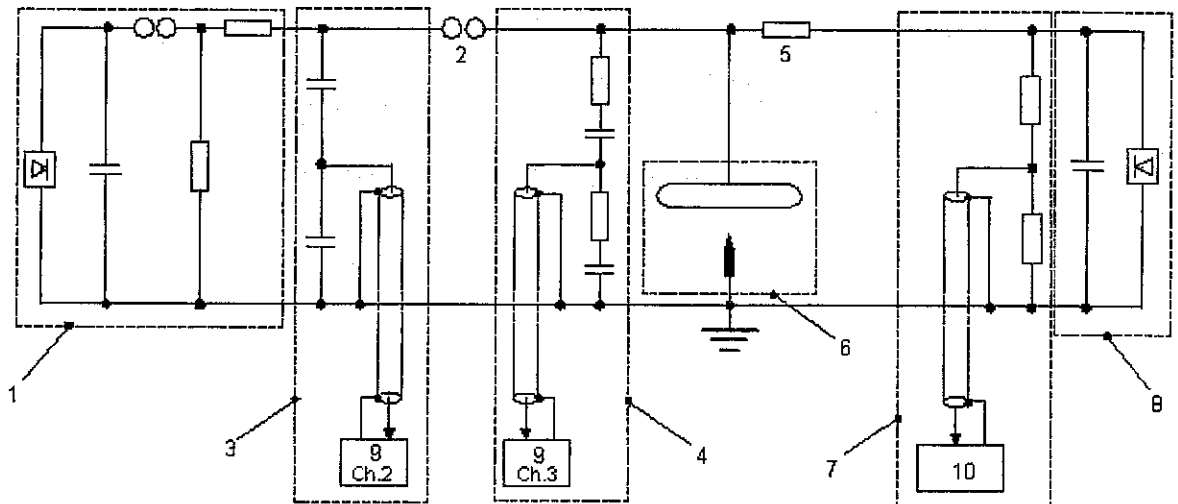

Photo 13

Test circuit diagram for testing E.S.E. conductors



- 1 - HV Impulse Generator 4.2MV-336kW;
- 2 - Serial protective gap $\Phi = 250$ mm;
- 3 - 4.2 MV measuring system;
- 4 - 1400 kV measuring system;
- 5 - Resistance $2M\Omega$;

- 6 - E.S.E. test configuration;
- 7 - 1 MV DC measuring system;
- 8 - Rectifier DC cascade GS 1000/30;
- 9 - Transient recorder TR-AS 100-10/4, channels 2 and 3;
- 10 - Digital multimeter KETHLEY.

TEST SET UP FOR EARLY STREAMER
EMISSION AIR TERMINAL

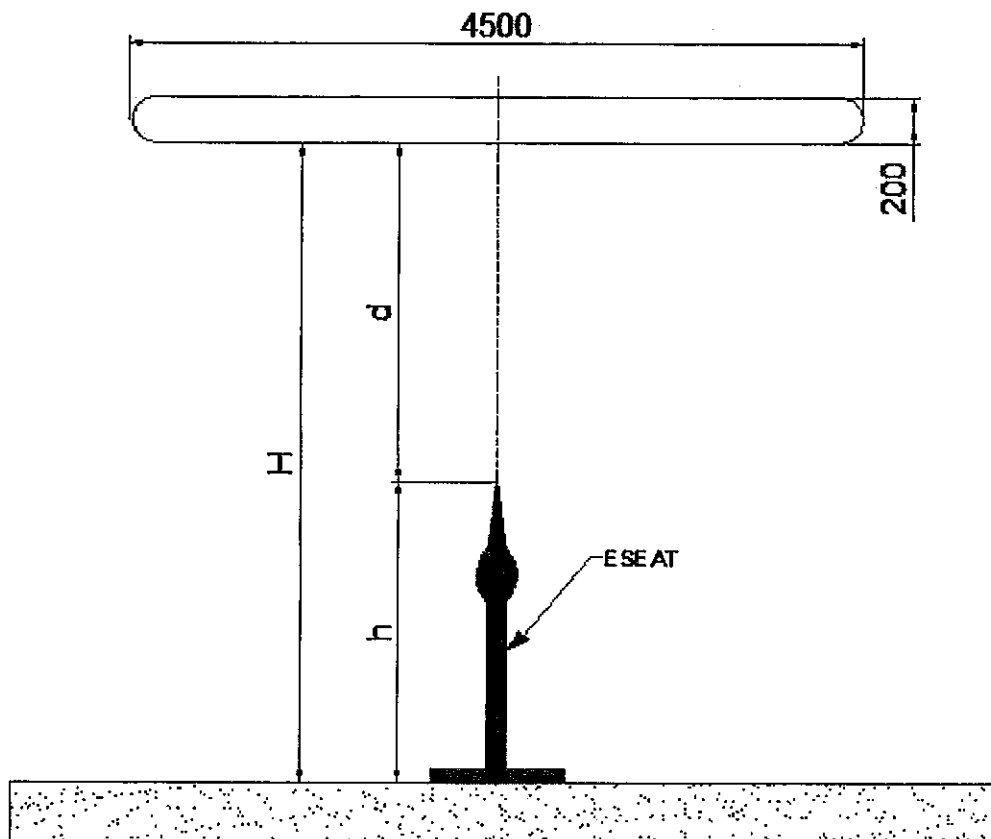

E.S.E. Lightning Conductors



S-A



The E.S.E. Lightning conductor S-A protects from a single point medium and large objects.

Specification - 60 µs	
Material:	stainless steel
Size:	59 x 12 cm
Weight:	2.8 kg
Protection Radius:	80 m
Installation Height:	5-6 m



MA Made in Austria

The Austrian company SCHIRTEC AG is certified to ISO 9001:2015 and ISO 14001:2015. The SCHIRTEC E.S.E. Lightning Conductor S-A is in accordance to the NFC 17-102: 2011 and the UNE 21186: 2011 Standards. The product is made of stainless steel, which is confirmed by TÜV Austria. The discharge capacity of lightning is confirmed in the laboratory BET.

Installation

Installation of S-A is simple and fast. The lightning arrester is installed on the top of the building and protects not only the building itself but also everything that is within the protective radius.

	Rp(m)				
	I	II	III	IV	
2	31	35	39	43	
3	47	52	58	64	
4	63	69	78	85	
5	79	86	97	107	
6	79	87	97	107	
8	79	87	98	108	
10	79	88	99	109	
20	80	89	102	113	
30	80	90	104	116	
60	80	90	105	120	

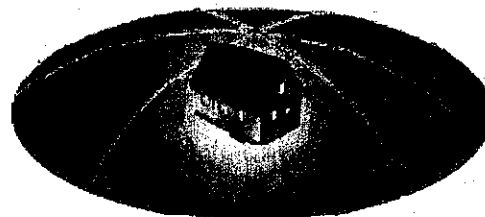

h – installation height
 Rp (m) – Protection Radius
 I | II | III | IV – Protection Level

SCHIRTEC AG
 Ignaz-Köck Straße 10
 A-1210 Wien, AUSTRIA

<http://www.schirtec.at>
info@schirtec.at
 Tel: +43 1 270 33 47 11



Annex 2

1	2	3	4																																																
TECHNICAL SPECIFICATIONS																																																			
A	<table border="1" style="width:100%; border-collapse: collapse;"> <tr> <th style="width:10%;">REV. NO.</th> <th style="width:60%;">DESCRIPTION</th> <th style="width:15%;">APPROVAL</th> <th style="width:15%;">REV. DATE</th> </tr> <tr> <td> </td> <td> </td> <td> </td> <td> </td> </tr> </table>			REV. NO.	DESCRIPTION	APPROVAL	REV. DATE																																												
REV. NO.	DESCRIPTION	APPROVAL	REV. DATE																																																
B																																																			
C																																																			
D																																																			
E																																																			
F	<table border="1" style="width:100%; border-collapse: collapse;"> <tr> <td style="width:25%;">PREPARED BY</td> <td style="width:25%;">NAME- SURNAME</td> <td style="width:15%;">DATE</td> <td style="width:35%;">SIGNATURE</td> </tr> <tr> <td> </td> <td> </td> <td>12.07.2019</td> <td> </td> </tr> <tr> <td>CONTROL</td> <td> </td> <td>12.07.2019</td> <td> </td> </tr> <tr> <td>APPROVAL</td> <td> </td> <td>12.07.2019</td> <td> </td> </tr> <tr> <td>MATERIAL</td> <td> </td> <td>WEIGHT</td> <td> </td> </tr> <tr> <td>MATERIAL STANDARD</td> <td> </td> <td> </td> <td> </td> </tr> <tr> <td>COATING & PAINT</td> <td> </td> <td> </td> <td> </td> </tr> <tr> <td colspan="3"> * UNIT OF MEASUREMENT : mm * NOT SPECIFIED IN THE DRAWING - TOLERANCES : MEASUREMENT on drawing * FINISHED PARTS FREE OF DIRT AND BURR * MEASUREMENTS CANNOT BE TAKEN FROM THE DRAWING </td> <td style="text-align:center;"> SCHIRTEC® <small>TECHNICAL SOLUTIONS</small> PART NAME SCHIRTEC_S-A_ PART NO / DRAWING NO SCH.101 </td> </tr> <tr> <td colspan="2">ISSUE DATE</td> <td>SCALE</td> <td>PAGE</td> </tr> <tr> <td colspan="2">12.07.2019</td> <td>1/1</td> <td>1</td> </tr> <tr> <td colspan="2">SIZE</td> <td colspan="2" style="text-align:center;"> </td> </tr> <tr> <td colspan="2">A4-H</td> <td colspan="2"> </td> </tr> </table>			PREPARED BY	NAME- SURNAME	DATE	SIGNATURE			12.07.2019		CONTROL		12.07.2019		APPROVAL		12.07.2019		MATERIAL		WEIGHT		MATERIAL STANDARD				COATING & PAINT				* UNIT OF MEASUREMENT : mm * NOT SPECIFIED IN THE DRAWING - TOLERANCES : MEASUREMENT on drawing * FINISHED PARTS FREE OF DIRT AND BURR * MEASUREMENTS CANNOT BE TAKEN FROM THE DRAWING			 SCHIRTEC® <small>TECHNICAL SOLUTIONS</small> PART NAME SCHIRTEC_S-A_ PART NO / DRAWING NO SCH.101	ISSUE DATE		SCALE	PAGE	12.07.2019		1/1	1	SIZE				A4-H			
PREPARED BY	NAME- SURNAME	DATE	SIGNATURE																																																
		12.07.2019																																																	
CONTROL		12.07.2019																																																	
APPROVAL		12.07.2019																																																	
MATERIAL		WEIGHT																																																	
MATERIAL STANDARD																																																			
COATING & PAINT																																																			
* UNIT OF MEASUREMENT : mm * NOT SPECIFIED IN THE DRAWING - TOLERANCES : MEASUREMENT on drawing * FINISHED PARTS FREE OF DIRT AND BURR * MEASUREMENTS CANNOT BE TAKEN FROM THE DRAWING			 SCHIRTEC® <small>TECHNICAL SOLUTIONS</small> PART NAME SCHIRTEC_S-A_ PART NO / DRAWING NO SCH.101																																																
ISSUE DATE		SCALE	PAGE																																																
12.07.2019		1/1	1																																																
SIZE																																																			
A4-H																																																			
ALL RIGHT RESERVED. WITHOUT WRITTEN CONSENT, NONE OF THE DETAILS IN THIS DOCUMENT MAY BE REPRODUCED, RECORDED, PRINTED OR DUPLICATED.																																																			
Rev Nr:	Rev / Ed:	Icclap / Edap (14 / 07 / 2019)	Pcap / Nr / Tr																																																

- End of the test report -